

Traufdetail / 3 S-Platte M 1:20

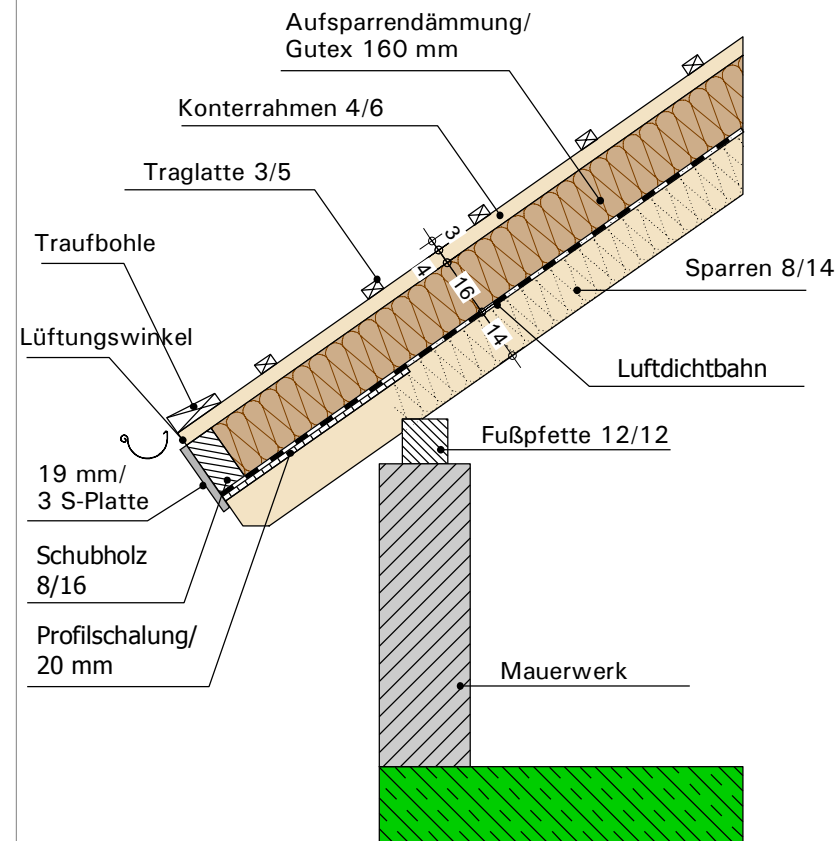

Isometrie Traufdetail / 3 S-Platte M 1:33

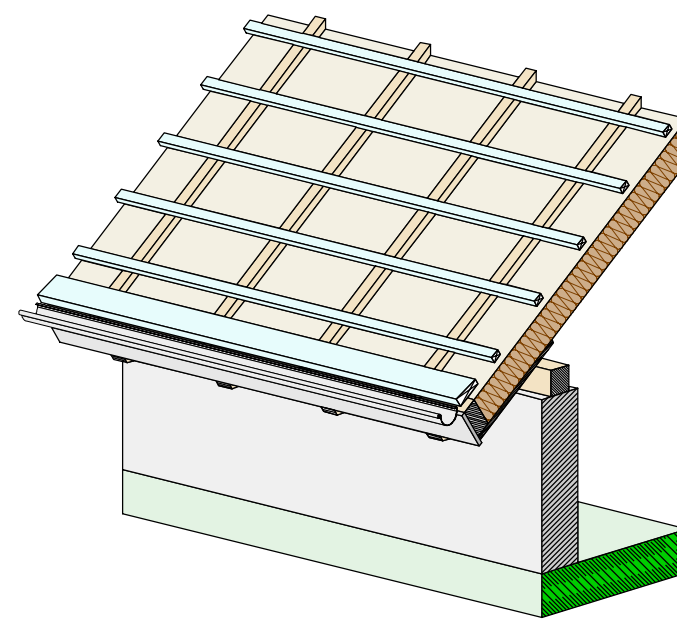

Isometrie / 3 S-Platte M 1:60

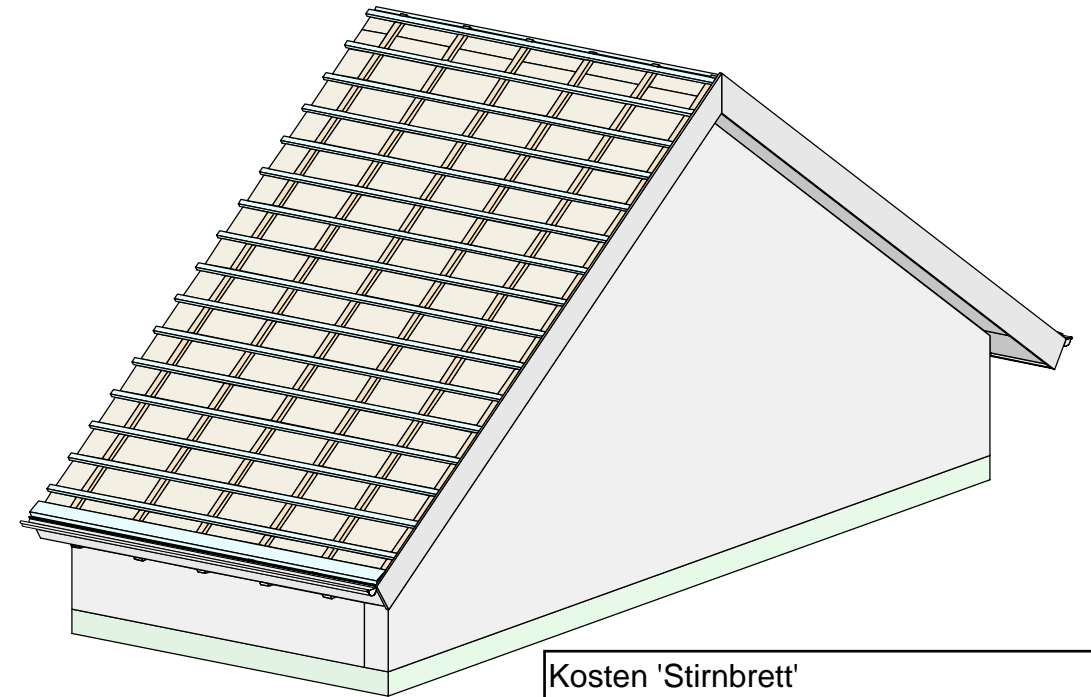

Kosten 'Stirnbrett'	
Standard Holz	30.- €/lfm
Glattkantblech	60.- €/lfm
Stehfalzblech	130.- €/lfm
Stand: April 2018	

Traufdetail / Stehfalzblech M 1:20

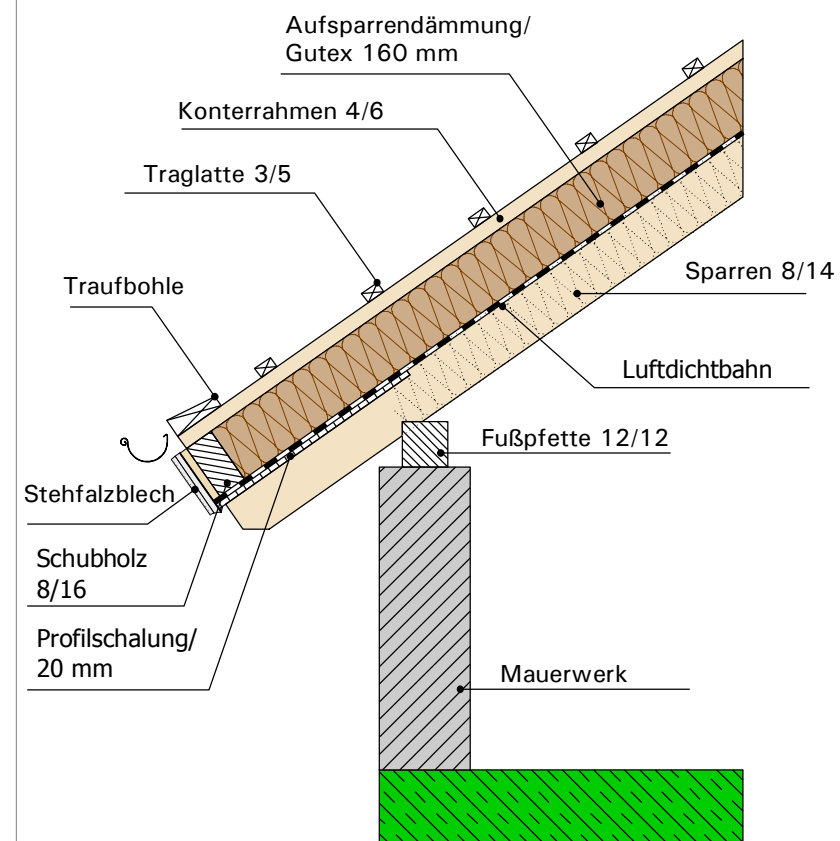

Isometrie Traufdetail / Stehfalzblech M 1:33

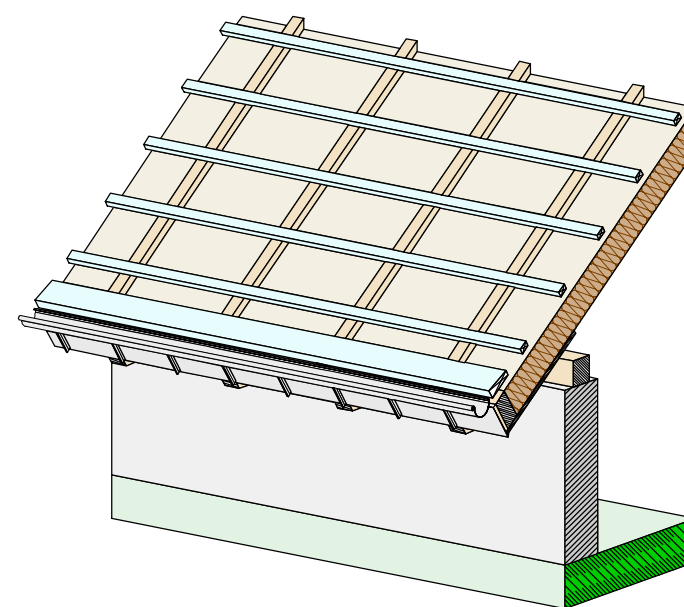

Isometrie / Stehfalzblech M 1:60

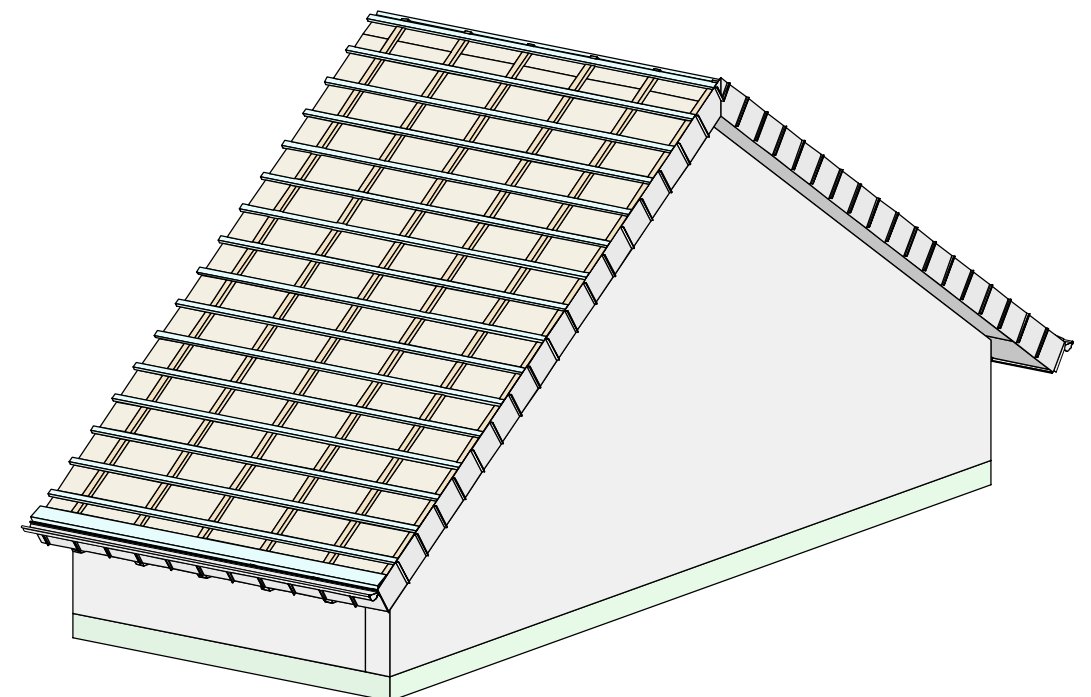

Detailkatalog Zimmerei Daum

Isometrie M 1:120

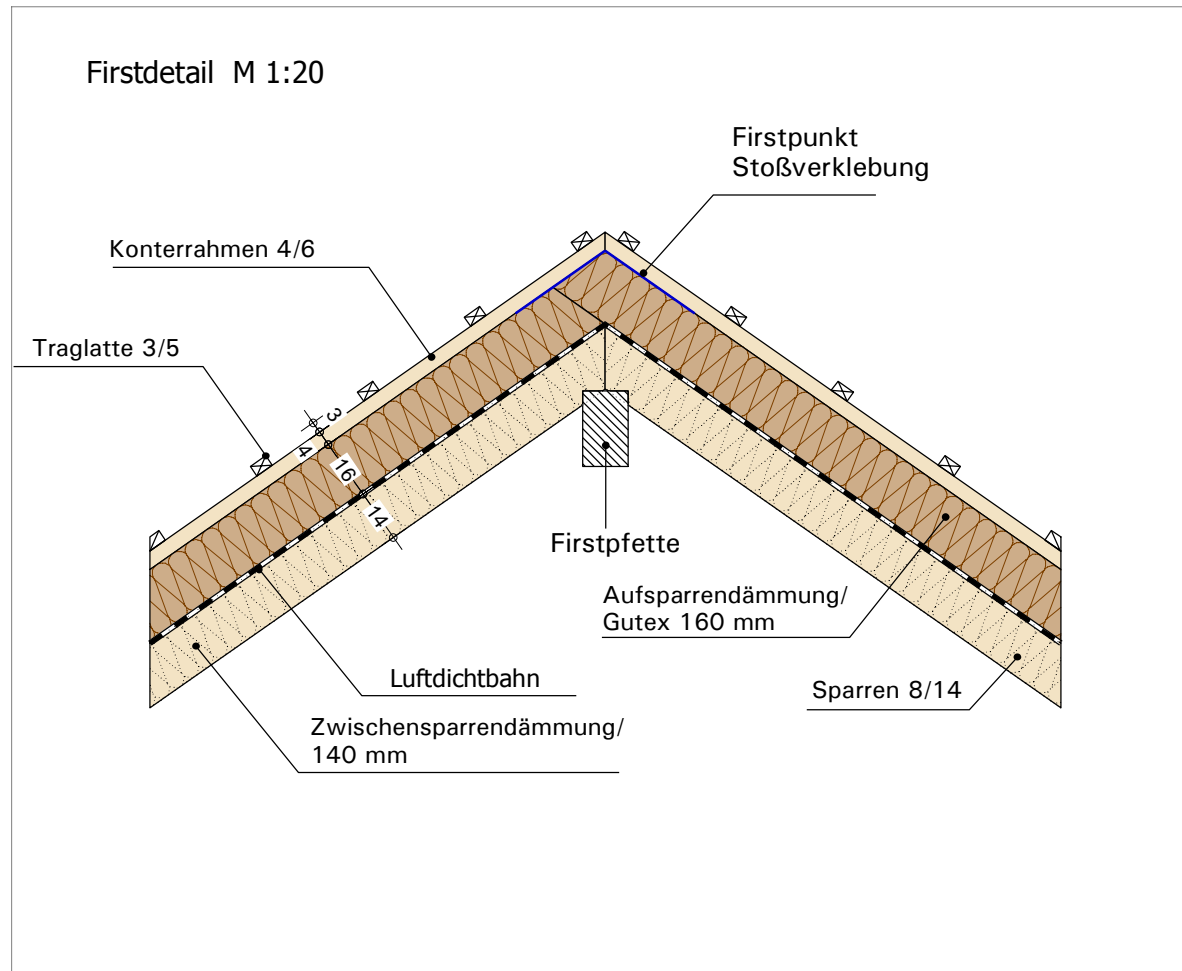

Isometrie / Firstdetail M 1:25

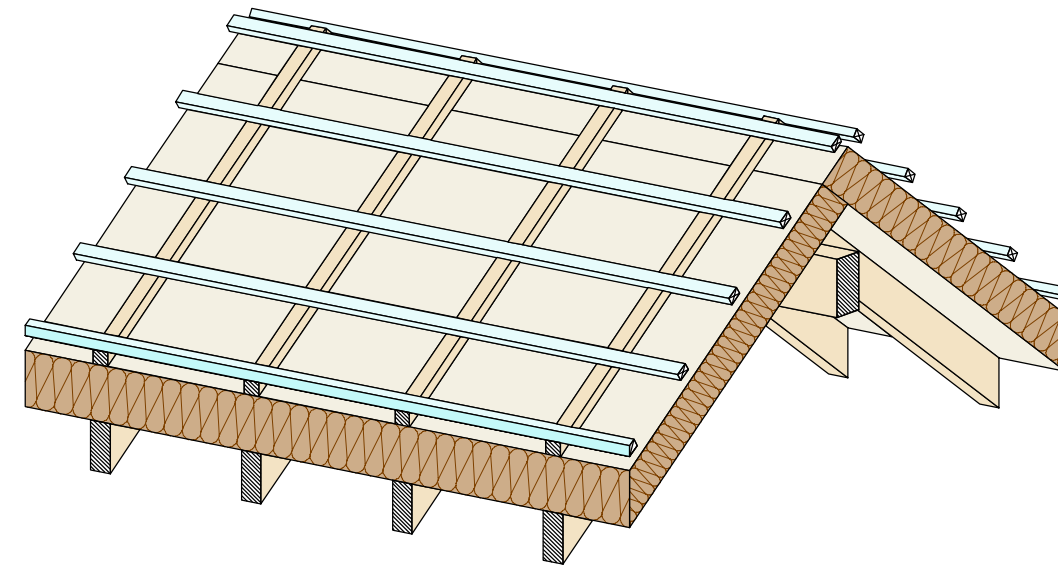

Ortgangdetail / 3 S-Platte M 1:20

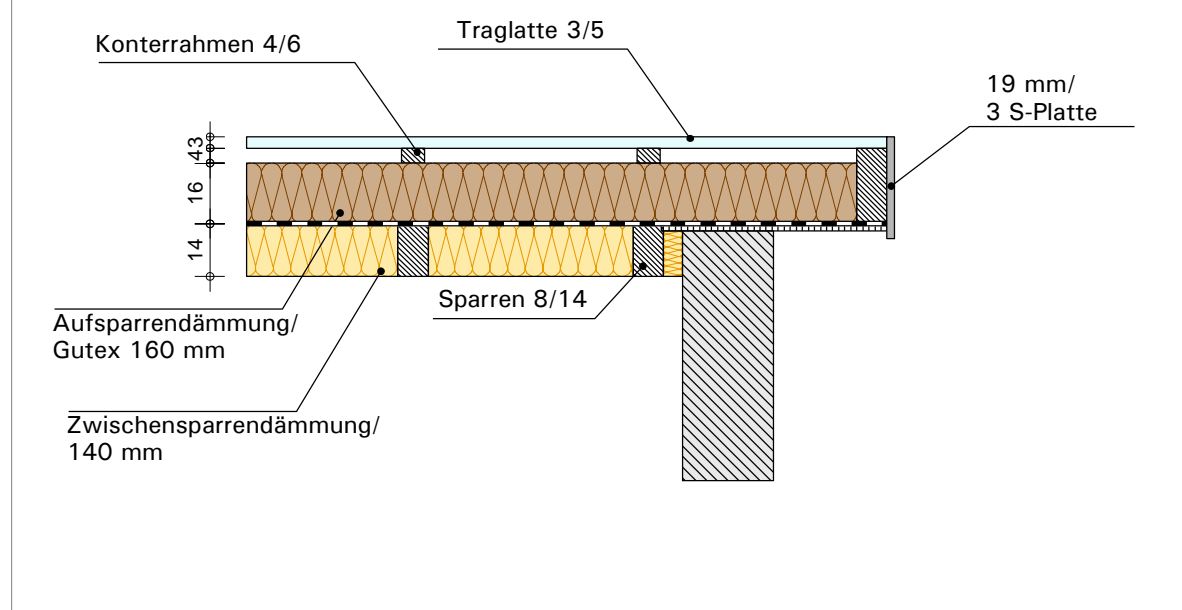

Ortgangdetail / Stehfalzblech M 1:20

